

標 示 章		海灣國際科技股份有限公司 Baytek International Technology	文件 編號	
			版次	1.3
			頁次	共 19 頁

BT-OLS-SOX03ST SERIES

POWERLED Component
Star Option
Lead (Pb) Free Product – RoHS Compliant

**BIT Lighting Component
3W Star Option Without Lens
Technical Datasheet
Version 1.3**

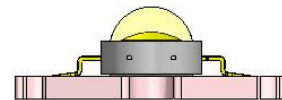
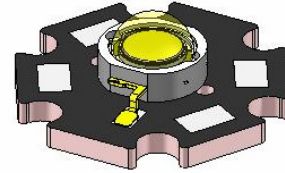

Features

- **High flux per LED**
- **Very long operating life (up to 100k hours)**
- **Various colors**
- **Viewing angle : 70 / 140 deg**
- **Good color uniformity**
- **More energy efficient than incandescent and most halogen lamps**
- **Low Voltage DC operated**
- **Instant light (less than 100ns)**
- **No UV**
- **Superior ESD protection**

Typical Applications

- **Reading lights (car, bus, aircraft)**
- **Portable (flashlight, bicycle)**
- **Uplighters/Downlighters**
- **Decorative/Entertainment**
- **Bollards/Security/Garden**
- **Cove/Undershelf/Task**
- **Indoor/Outdoor Commercial and Residential Architectural**
- **Automotive Ext (Stop-Tail-Turn, CHMSL, Mirror Side Repeat)**
- **LCD backlights**

Mechanical Dimensions

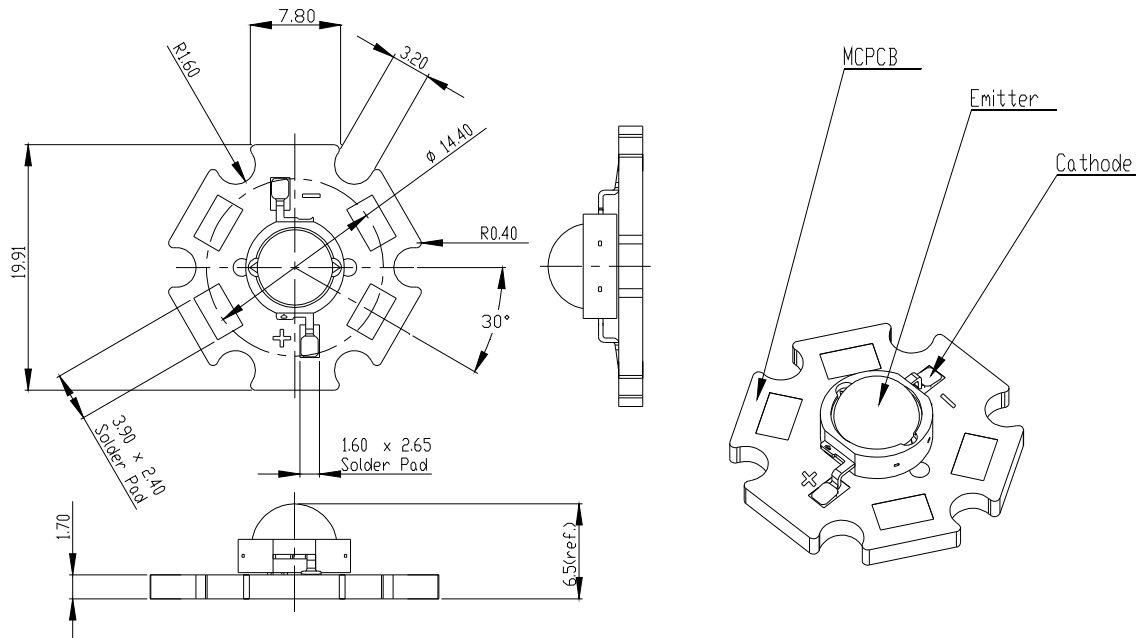

Notes

- Slots in aluminum-core PCB for M3 or #4 mounting screw.
- Electrical interconnection pads labeled on the aluminum-core PCB with "+" and "-" to denote positive and negative, respectively. All positive pads are interconnected, as are all negative pads, allowing for flexibility in array interconnection.
- Do not subject to temperatures greater than 75°C as plastic deformation may occur.
- Protect collimator against exposure to solvents and adhesives that are not compatible with it. Use care in handling the optic to avoid scratches or other damage that will effect the optical performance.
- Drawing not to scale.
- All dimensions are in millimeters.
- All dimensions without tolerances are for reference only.
- Please do not use a force of over 3kgf impact or pressure on the lens of the LED, otherwise it will cause a catastrophic failure.

**The appearance and specifications of the product may be modified for improvement without notice.

High Power 3W Star Module series Nomenclature

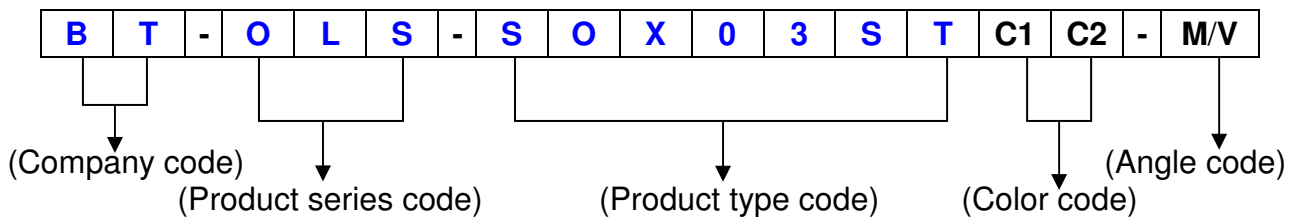

Flux Characteristics of LED at 700mA, T_J = 25 °C

Radiation	Color	Part Number	Minimum	Typical
Dome / Lambertian	White	OLS-SOX03STNW-M/V	67.2	110
	Warm White	OLS-SOX03STWW-M/V	67.2	110
	Green	OLS-SOX03STPG-M/V	87.4	105
	Blue	OLS-SOX03STNB-M/V	18.1	26
	Yellow	OLS-SOX03STNY-M/V	58.9	84
	Amber	OLS-SOX03STNA-M/V	58.9	84
	Red	OLS-SOX03STNR-M/V	58.9	80

- BIT maintains a tolerance of ± 10% on flux and power measurements.
- Please do not drive at rated current more than 3 second without proper heat sink.
- M means 70 deg ; V means 140 deg

Electrical Characteristics of Module at 700mA, T_J = 25 °C

Color	Forward Voltage V _F (V)			Dynamic Resistance	Temperature Coefficient of V _F (mV/25 °C) Δ V _F / Δ T _J	Thermal Resistance Junction to Board (° /W)
	Min	Typ	Max			
White	2.8	3.5	4.3	1.0	-2.0	8
Warm White	2.8	3.5	4.3	1.0	-2.0	8
Green	2.8	3.5	4.3	1.0	-2.0	8
Blue	2.8	3.5	4.3	1.0	-2.0	8
Yellow	1.9	2.2	3.1	2.4	-2.0	10
Amber	1.9	2.2	3.1	2.4	-2.0	10
Red	1.9	2.2	3.1	2.4	-2.0	10

Optical Characteristics of Module at 700mA, T_J = 25 °C

Radiation	Color	Min	Typ.	Max.	Δλ _{1/2}	Δλ _D /ΔT _J	Ø _{0.9v}	2Ø _{1/2}
Dome / Lambertian	White	4100K	5500K	10000K	---	---	90/160	70/140
	Warm White	2700K	3300K	4100K	---	---	90/160	70/140
	Green	515 nm	525 nm	535 nm	35	0.04	90/160	70/140
	Blue	455 nm	465 nm	475 nm	25	0.04	90/160	70/140
	Yellow	580 nm	589 nm	600 nm	20	0.05	90/160	70/140
	Amber	600 nm	608 nm	620 nm	20	0.05	90/160	70/140
	Red	620 nm	625 nm	635 nm	20	0.05	90/160	70/140

- BIT maintains a tolerance of ± 1nm for dominant wavelength measurements.
- BIT maintains a tolerance of ± 5% for CCT measurements.

Absolute Maximum Ratings

Parameter	White / Warm White /	Yellow / Amber / Red
	Green / Blue	
DC Forward Current (mA)	700	700
Peak Pulsed Forward Current (mA)	1000	1000
Average Forward Current (mA)	700	700
ESD Sensitivity	± 16000V HBM	
LED Junction Temperature (° C)	135	120
Aluminum- Core PCB Temperature (° C)	105	105
Storage & Operating Temperature (° C)	-40 to +105	-40 to +105
Soldering Temperature (° C)	260 for 5 seconds Max.	

Photometric Luminous Flux Bin Structure of LED

Color	Bin Code	Minimum Photometric Flux (lm)	Maximum Photometric Flux (lm)
White	T2	76.6	87.4
	U1	87.4	99.6
	U2	99.6	113.6
	V1	113.6	129.5
	V2	129.5	147.7
Warm White	T2	76.6	87.4
	U1	87.4	99.6
	U2	99.6	113.6
	V1	113.6	129.5
Green	U1	87.4	99.6
	U2	99.6	113.6
	V1	113.6	129.5
	V2	129.5	147.7
Blue	N	18.1	23.5
	P	23.5	30.6
	Q	30.6	39.8
Yellow	S2	58.9	67.2
	T1	67.2	76.6
	T2	76.6	87.4
Amber	U1	87.4	99.6
	S2	58.9	67.2
	T1	67.2	76.6
	T2	76.6	87.4
Red	U1	87.4	99.6
	S2	58.9	67.2
	T1	67.2	76.6
	T2	76.6	87.4

- BIT maintains a tolerance of ± 10% on flux and power measurements.

Color Bin

White and Warm White Binning Structure Graphical Representation

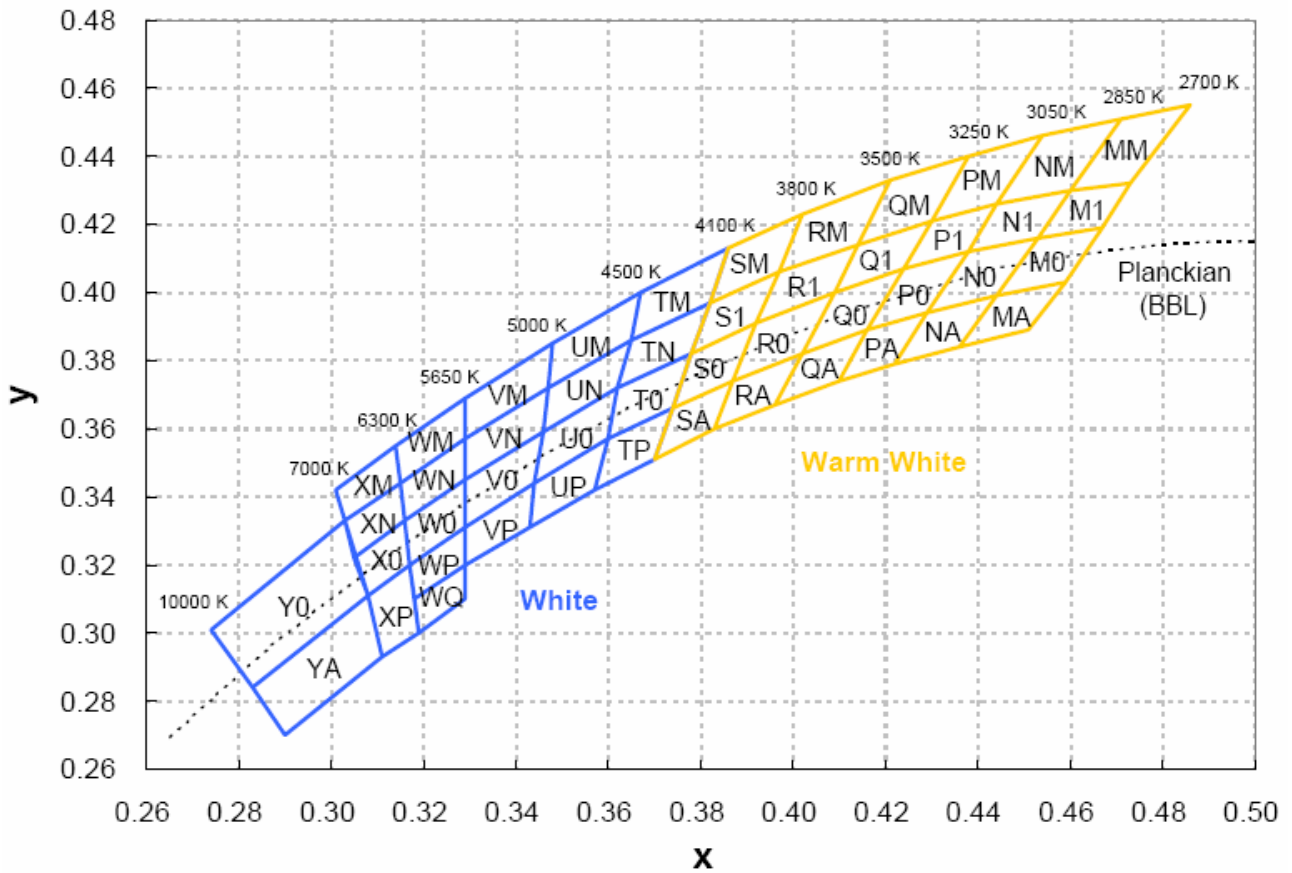

White Bin Structure

Bin Code	x	y	Typ. CCT (K)	Bin Code	x	y	Typ. CCT (K)
T0	0.378	0.382	4300	W0	0.329	0.345	5970
	0.374	0.366			0.329	0.331	
	0.360	0.357			0.317	0.320	
	0.362	0.372			0.316	0.333	
TN	0.382	0.397	4300	WN	0.329	0.345	5970
	0.378	0.382			0.316	0.333	
	0.362	0.372			0.315	0.344	
	0.365	0.386			0.329	0.357	
TP	0.374	0.366	4300	WP	0.329	0.331	5970
	0.370	0.351			0.329	0.320	
	0.357	0.342			0.318	0.310	
	0.360	0.357			0.317	0.320	
TM	0.386	0.413	4300	WQ	0.329	0.320	5970
	0.382	0.397			0.329	0.310	
	0.365	0.386			0.319	0.300	
	0.367	0.400			0.318	0.310	
U0	0.362	0.372	4750	WM	0.329	0.369	5970
	0.360	0.357			0.329	0.357	
	0.344	0.344			0.315	0.344	
	0.346	0.359			0.314	0.355	
UN	0.365	0.386	4750	X0	0.308	0.311	6650
	0.362	0.372			0.305	0.322	
	0.346	0.359			0.316	0.333	
	0.347	0.372			0.317	0.320	
UP	0.360	0.357	4750	XN	0.305	0.322	6650
	0.357	0.342			0.303	0.333	
	0.343	0.331			0.315	0.344	
	0.344	0.344			0.316	0.333	
UM	0.365	0.386	4750	XP	0.308	0.311	6650
	0.367	0.400			0.317	0.320	
	0.348	0.385			0.319	0.300	
	0.347	0.372			0.311	0.293	
V0	0.329	0.331	5320	XM	0.301	0.342	6650
	0.329	0.345			0.314	0.355	
	0.346	0.359			0.315	0.344	
	0.344	0.344			0.303	0.333	
VN	0.329	0.345	5320	Y0	0.308	0.311	8000
	0.329	0.357			0.283	0.284	
	0.347	0.372			0.274	0.301	
	0.346	0.359			0.303	0.333	
VP	0.329	0.331	5320	YA	0.308	0.311	8000
	0.344	0.344			0.311	0.293	
	0.343	0.331			0.290	0.270	
	0.329	0.320			0.283	0.284	
VM	0.329	0.357	5320				
	0.329	0.369					
	0.348	0.385					
	0.347	0.372					

- Tolerance on each color bin (x, y) is ± 0.01

Note : Although several bins are outlined, product availability in a particular bin varies by production run and by product performance. Not all bins are available in all colors.





Warm White Bin Structure

Bin Code	x	y	Typ. CCT (K)	Bin Code	x	y	Typ. CCT (K)
M0	0.453	0.416	2770	Q0	0.409	0.400	3370
	0.444	0.399			0.402	0.382	
	0.459	0.403			0.416	0.389	
	0.467	0.419			0.424	0.407	
M1	0.460	0.430	2770	Q1	0.414	0.414	3370
	0.453	0.416			0.409	0.400	
	0.467	0.419			0.424	0.407	
	0.473	0.432			0.430	0.421	
MA	0.459	0.403	2770	QA	0.416	0.389	3370
	0.444	0.399			0.402	0.382	
	0.436	0.384			0.396	0.367	
	0.451	0.389			0.410	0.374	
MM	0.471	0.451	2770	QM	0.421	0.433	3370
	0.460	0.430			0.414	0.414	
	0.473	0.432			0.430	0.421	
	0.486	0.455			0.438	0.440	
N0	0.438	0.412	2950	R0	0.392	0.391	3650
	0.429	0.394			0.387	0.374	
	0.444	0.399			0.402	0.382	
	0.453	0.416			0.409	0.400	
N1	0.444	0.426	2950	R1	0.414	0.414	3650
	0.438	0.412			0.409	0.400	
	0.453	0.416			0.392	0.391	
	0.460	0.430			0.397	0.406	
NA	0.444	0.399	2950	RA	0.387	0.374	3650
	0.429	0.394			0.383	0.360	
	0.422	0.379			0.396	0.367	
	0.436	0.384			0.402	0.382	
NM	0.454	0.446	2950	RM	0.421	0.433	3650
	0.444	0.426			0.414	0.414	
	0.460	0.430			0.397	0.406	
	0.471	0.451			0.402	0.423	
P0	0.424	0.407	3150	S0	0.392	0.391	3950
	0.416	0.389			0.387	0.374	
	0.429	0.394			0.374	0.366	
	0.438	0.412			0.378	0.382	
P1	0.430	0.421	3150	S1	0.397	0.406	3950
	0.424	0.407			0.392	0.391	
	0.438	0.412			0.378	0.382	
	0.444	0.426			0.382	0.397	
PA	0.429	0.394	3150	SA	0.387	0.374	3950
	0.416	0.389			0.383	0.360	
	0.410	0.374			0.370	0.351	
	0.422	0.379			0.374	0.366	
PM	0.438	0.440	3150	SM	0.402	0.423	3950
	0.430	0.421			0.397	0.406	
	0.444	0.426			0.382	0.397	
	0.454	0.446			0.386	0.413	

- Tolerance on each color bin (x, y) is ± 0.01

Note : Although several bins are outlined, product availability in a particular bin varies by production run and by product performance. Not all bins are available in all colors.

Dominant Wavelength Bin Structure

Color	Bin Code	Minimum Dominant Wavelength (nm)	Maximum Dominant Wavelength (nm)
	A	515	520
	1	520	525
	2	525	530
	3	530	535
	A	455	460
	1	460	465
	2	465	470
	3	470	475
	2	580	585
	4	585	590
	6	590	595
	7	595	600
	2	600	605
	4	605	610
	6	610	615
	7	615	620
	2	620	625
	4	625	630
	6	630	635

- BIT maintains a tolerance of ± 1 nm for dominant wavelength measurements.

Note : Although several bins are outlined, product availability in a particular bin varies by production run and by product performance. Not all bins are available in all colors.

Color Spectrum, $T_J = 25^\circ\text{C}$

1. White

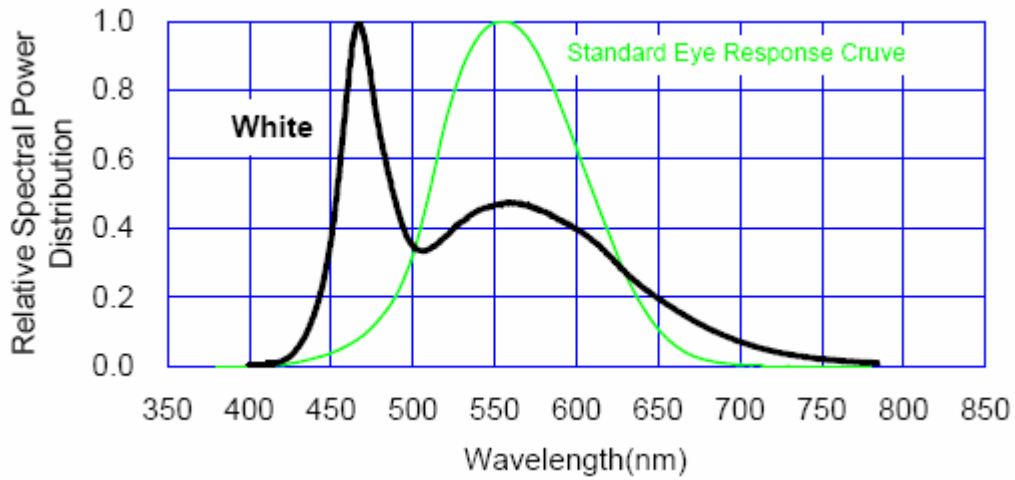

2. Warm White

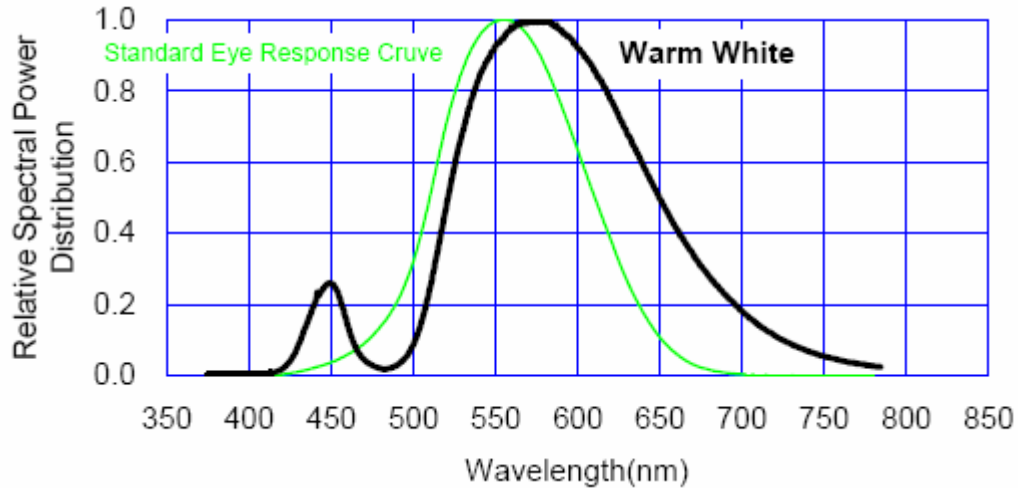

3. Blue, Green, Amber, Red

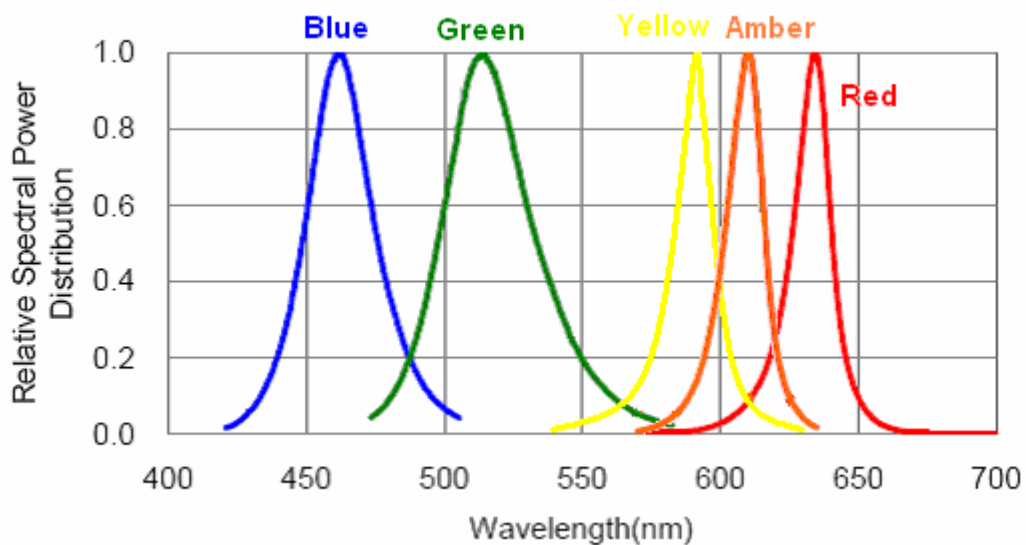

Light Output Characteristics

Relative Light Output vs. Junction Temperature at 700mA

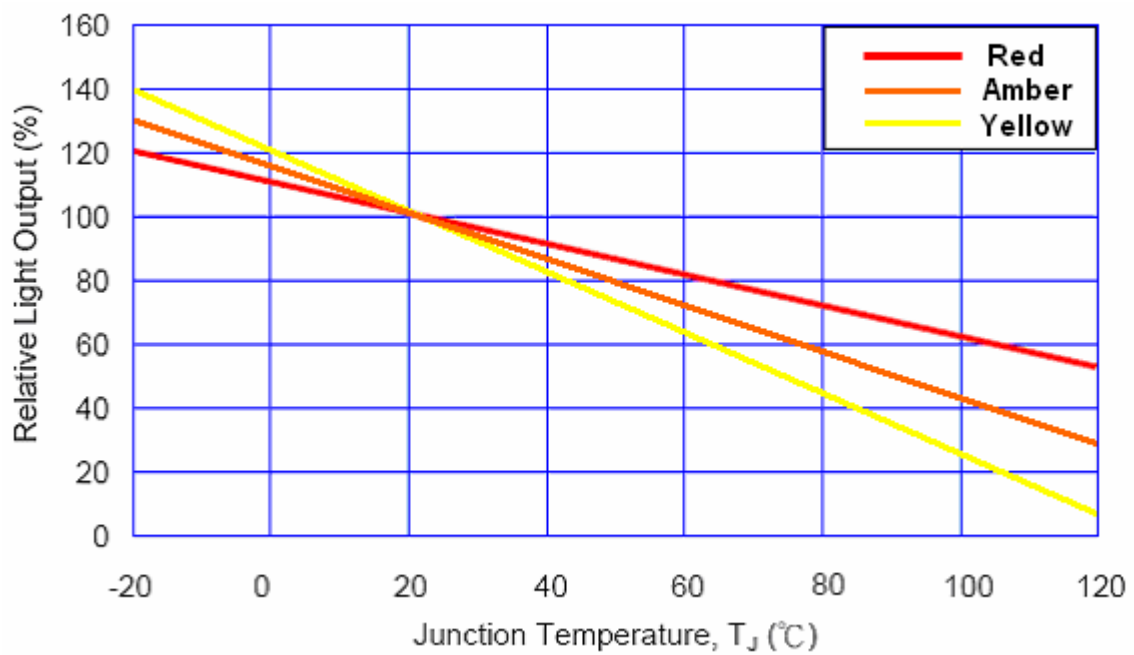
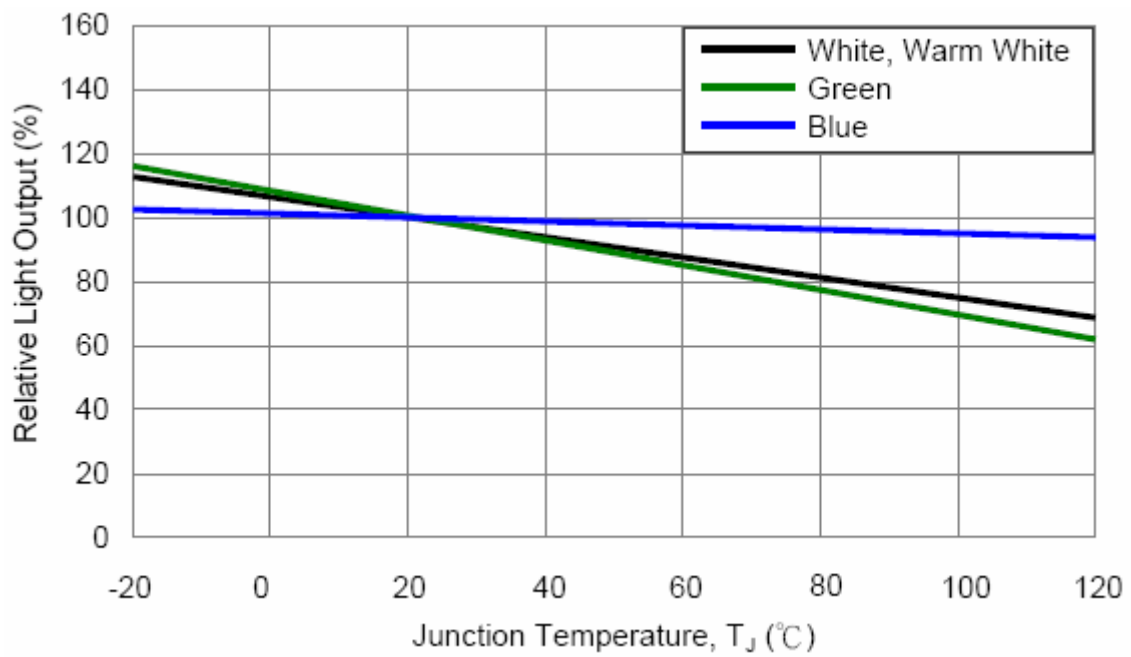

Forward Current Characteristics, $T_J = 25 \text{ }^\circ\text{C}$

Forward Voltage vs. Forward Current

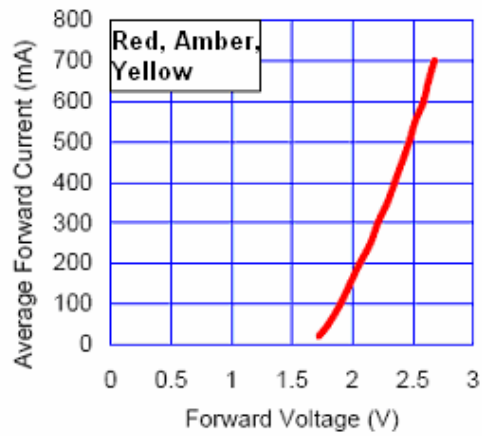
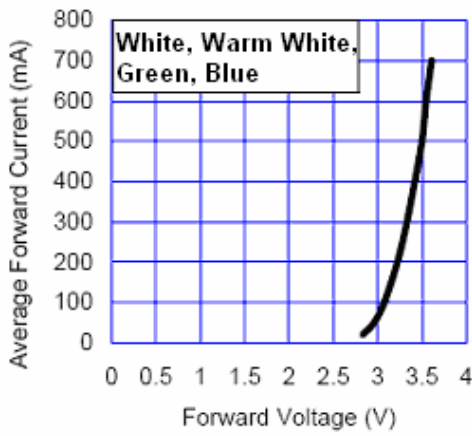

Forward Current vs. Normalized Relative Luminous Flux

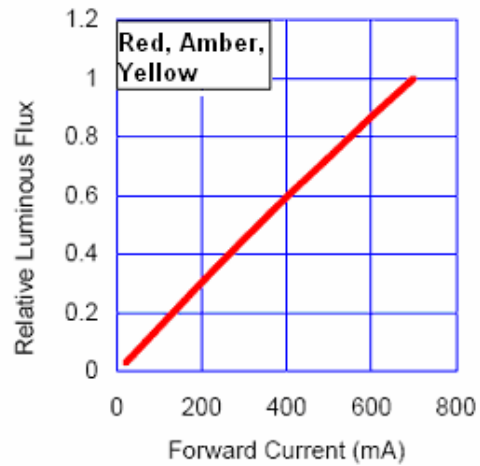
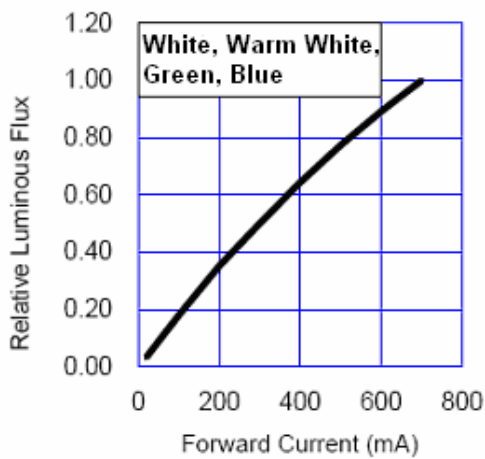

Life Intensity

Life Intensity

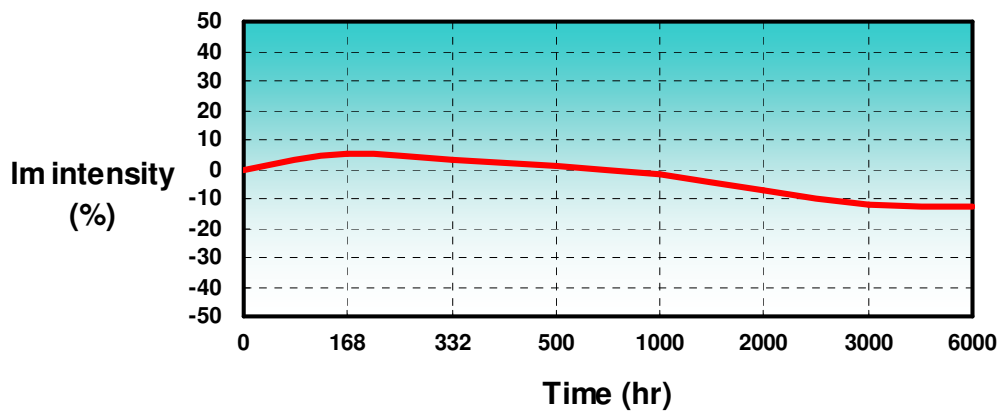

Ambient Temperature vs. Maximum Forward Current

1. White, Warm White, Green, Blue ($T_{JMAX} = 135^\circ\text{C}$)

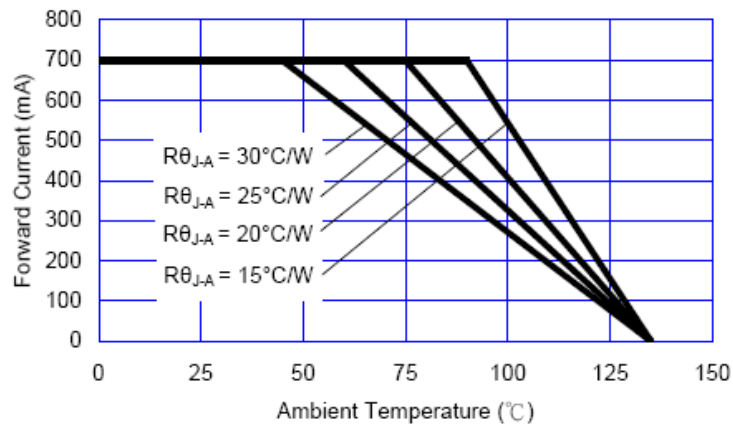

2. Red, Amber, Yellow ($T_{JMAX} = 120^\circ\text{C}$)

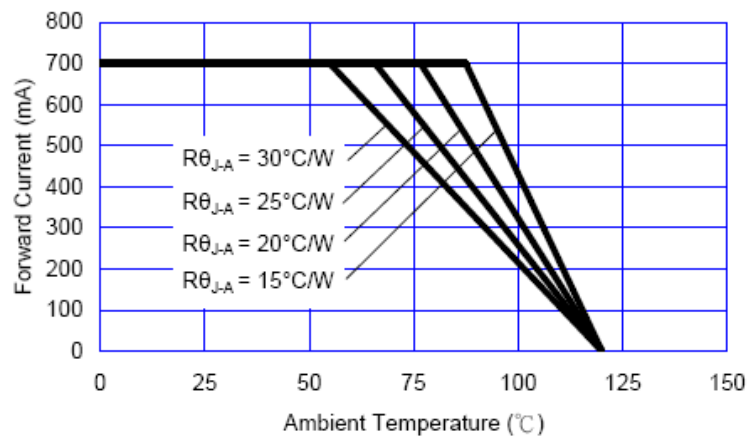

Typical Representative Spatial Radiation Pattern

Dome Radiation Pattern

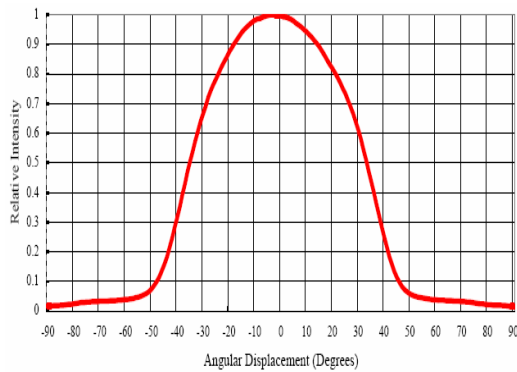

(70 deg)

Lambertian Radiation Pattern

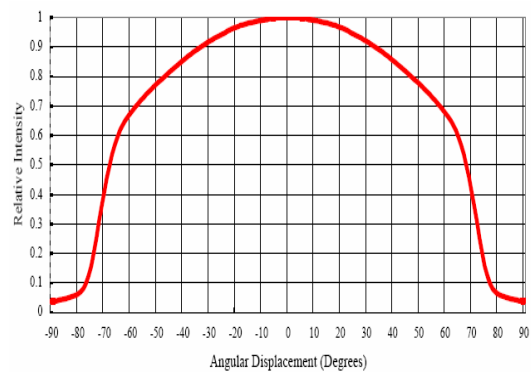

(140 deg)

Qualification Reliability Testing

Stress Test	Stress Conditions	Stress Duration	Failure Criteria
Room Temperature Operating Life (RTOL)	25 ° C, IF = max DC (Note 1)	1000 hours	Note 2
Wet High Temperature Operating Life (WHTOL)	85 ° C/60%RH, IF = max DC (Note 1)	1000 hours	Note 2
Wet High Temperature Storage Life (WHTSL)	85 ° C/85 %RH, non-operating	1000 hours	Note 2
High Temperature Storage Life(HTSL)	110 ° C, non-operating	1000 hours	Note 2
Low Temperature Storage Life (LTSL)	-40 ° C, non-operating	1000 hours	Note 2
Non-operating Temperature Cycle (TMCL)	-40 ° C TO 120 ° C, 30 min. dwell, <5 min. transfer	200 cycles	Note 2
Non-operating Thermal Shock (TMSK)	-40 ° C TO 120 ° C, 20 min. dwell, <20 sec.. transfer	200 cycles	Note 2
Mechanical Shock	1500G, 0.5 msec. pulse, 5 shocks each 6 axis		Notes 3
Natural Drop	On concrete from 1.2m, 3X		Notes
Variable Vibration Frequency	10-2000-10 Hz, log or linear sweep rate, 20G about 1 min, 1.5mm, 3X/axis		
Solder heat Resistance (SHR)	260 ° C ± 5 ° C, 10 sec		Note 3
Solderability	Steam age for 16 hrs., then solder dip at 260 ° C for 5 sec.		Solder coverage on lead

Notes:

1. Depending on the maximum derating curve.
2. Criteria for judging failure

Item	Test Condition	Criteria for Judgment	
		Min.	Max.
Forward Voltage (VF)	IF = max DC	-	Initial Level x 1.1
Luminous Flux or Radiometric Power (Φ_v)	IF = max DC	Initial Level x 0.7	-
Reverse Current (IR)	VR = 5V	-	50 μ A

- The test is performed after the LED is cooled down to the room temperature

3. A failure is an LED that is open or shorted.

Recommended Solder Pad Design

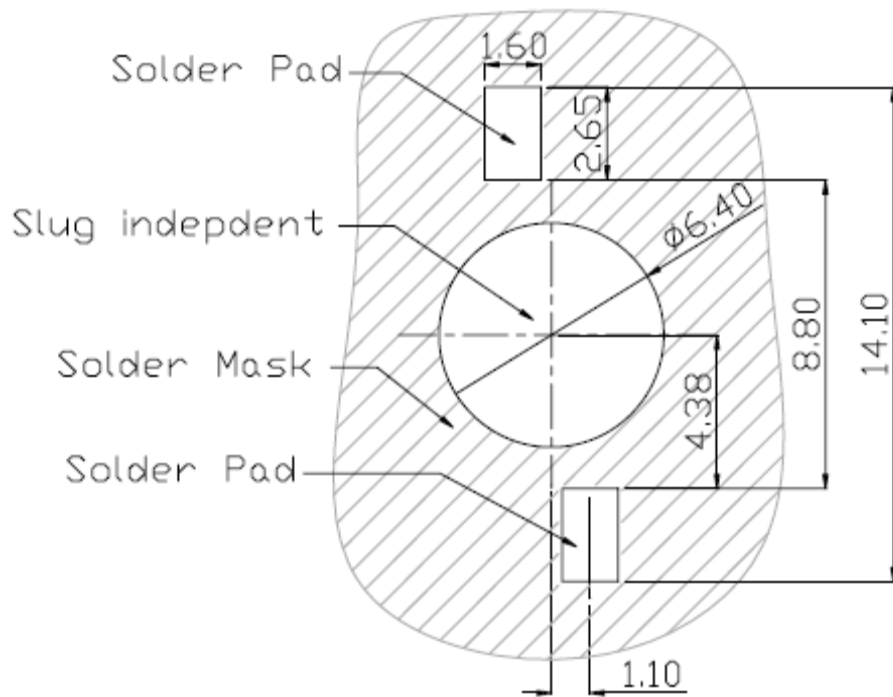

- All dimensions are in millimeters
- Electrical isolation is required between Slug and Solder Pad.

Reflow Soldering Condition

Profile Feature	Sn-Pb Eutectic Assembly	Lead(Pb)-Free Assembly
Average Ramp-Up Rate (T_{smax} to T_p)	3 ° C / second max	3 ° C / second max
Preheat		
-Temperature Min (T_{smin})	100 ° C	150 ° C
-Temperature Max (T_{smax})	150 ° C	200 ° C
-Time (t_{smin} to t_{smax})	60-120 seconds	60-180 seconds
Time maintained above:		
-Temperature (T_L)	183 ° C	217 ° C
-Time (t_L)	60-150 seconds	60-150 seconds
Peak/Classification Temperature (T_p)	240 ° C	260 ° C
Time within 5 ° C of Actual Peak Temperature (t_p)	10-30 seconds	20-40 seconds
Ramp-Down Rate	6 ° C/seconds max.	6 ° C/seconds max.
Time 25 ° C to Peak Temperature	6 minutes max.	8 minutes max.

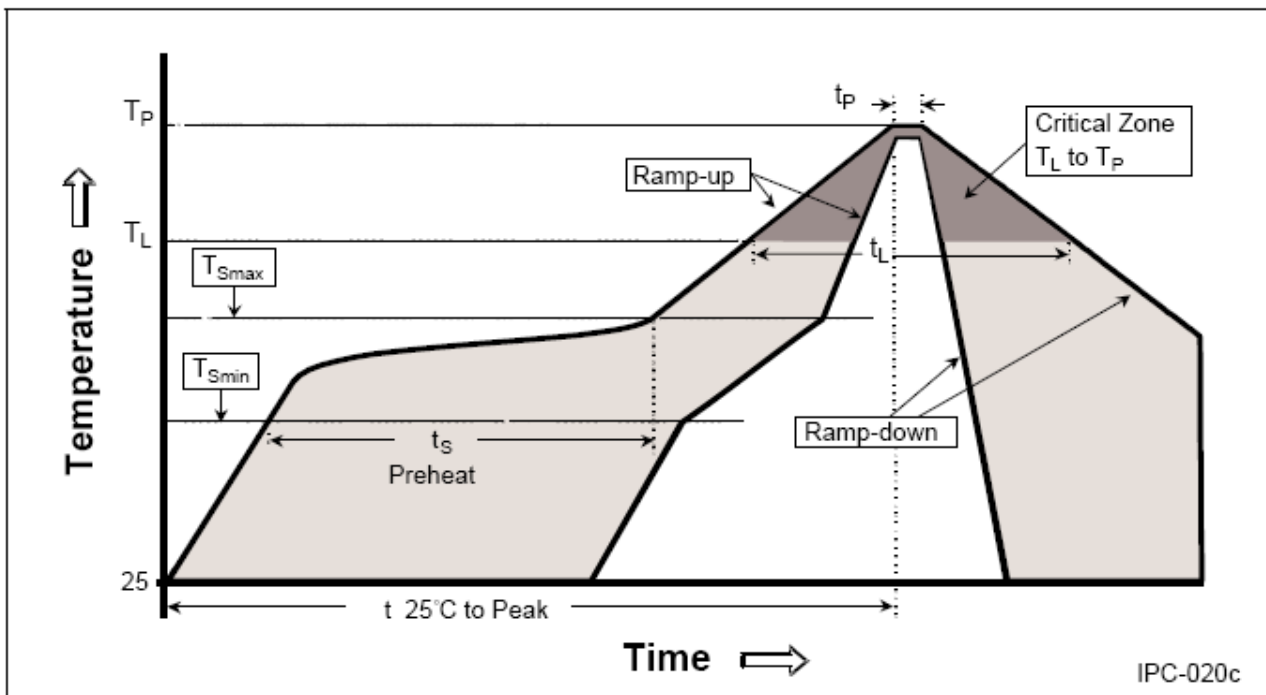

- All temperatures refer to topside of the package, measured on the package body surface.
- Repairing should not be done after the LEDs have been soldered. When repairing is unavoidable, a heat plate should be used. It should be confirmed beforehand whether the characteristics of LEDs or will not be damaged by repairing.
- Reflow soldering should not be done more than two times.
- When soldering, do not put stress on the LEDs during heating.
- After soldering, do not warp the circuit board.

Heat Plate Soldering Condition

(1) Soldering Process for Solder Paste

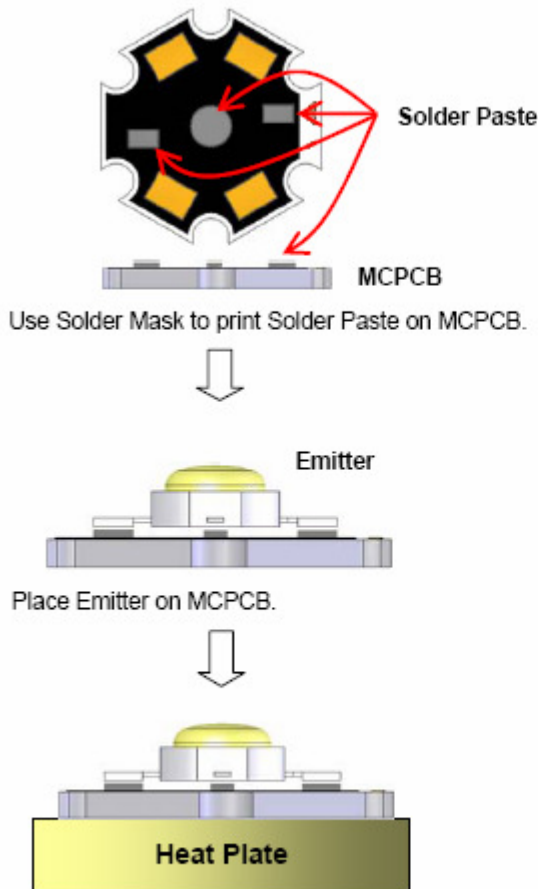

Put MCPCB on Heat Plate until Solder Paste melt.
The Solder Paste could be melted within 10 seconds.
Take out MCPCB out from Heat Plate within 15 seconds.

- Heat plate temperature: 230 ° C max for Lead Solder and 260 ° C max for Lead-Free Solder.
- When soldering, do not put stress on the LEDs during heating.
- After soldering, do not warp the circuit board.

(2) Soldering Process for Solder Wire

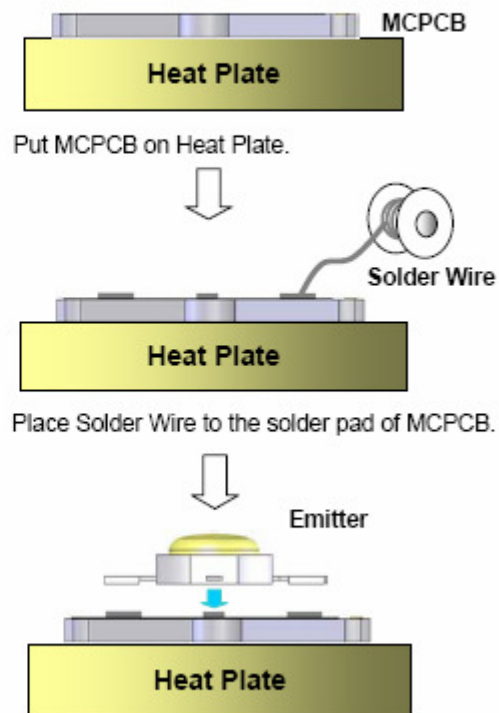

Put Emitter on MCPCB. Take the MCPCB out from Heat Plate within 10 seconds.

Manual Hand Soldering

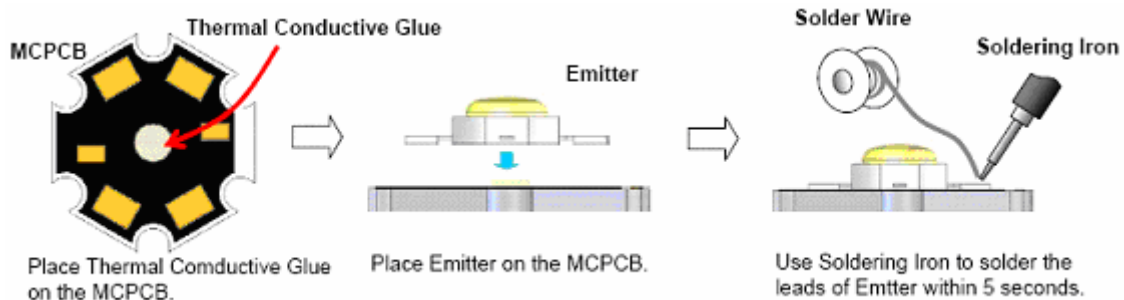

- For prototype builds or small series production runs it possible to place and solder the emitters by hand.
- Solder tip temperature: 230 ° C max for Lead Solder and 260 ° C max for Lead-Free Solder.
- Avoiding damage to the emitter or to the MCPCB dielectric layer. Damage to the epoxy layer can cause a short circuit in the array.
- Do not let the solder contact from solder pad to back-side of MCPCB. This one will cause a short circuit and damage emitter.

Star Tube Packing

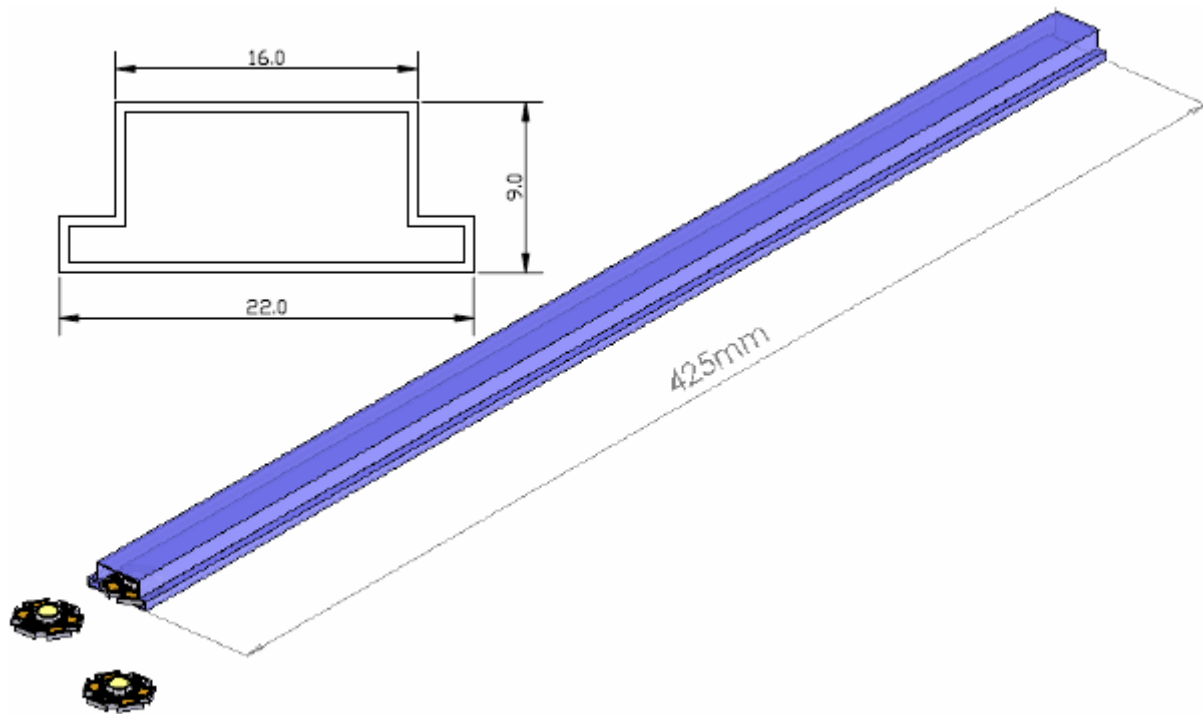

Notes:

- 20 pieces per tube.
- Drawing not to scale.
- All dimensions are in millimeters.
- All dimensions without tolerances are for reference only.

**Please do not open the moisture barrier bag (MBB) more than one week. This may cause the leads of LED discoloration. We recommend storing BIT's LEDs in a dry box after opening the MBB. The recommended storage conditions are temperature 5 to 30 ° C and humidity less than 40% RH.

Precaution for Use

- Storage
Please do not open the moisture barrier bag (MBB) more than on week. This may cause the leads of LED discoloration. We recommend storing BIT's LEDs in a dry box after opening the MBB. The recommended storage conditions are temperature 5 to 30 ° C and humidity less than 40% RH. It is also recommended to return the LEDs to the MBB and to reseal the MBB.
- The slug is not electrically neutral. Therefore, we recommend to isolate the heat sink.
- The slug is to be soldered. If no, please use the heat conductive adhesive.
- Any mechanical force or any excess vibration shall not be accepted to apply during cooling process to normal temperature after soldering.
- Please avoid rapid cooling after soldering.
- Components should not be mounted on warped direction of PCB.
- Repairing should not be done after the LEDs have been soldered. When repairing is unavoidable, a heat plate should be used. It should be confirmed beforehand whether the characteristics of the LEDs will or will not be damaged by repairing.
- The device should not be used in any type of fluid such as water, oil, organic solvent and etc. When cleaning is required, isopropyl alcohol should be used.
- When the LEDs are illuminating, operating current should be decided after considering the package maximum temperature.
- The appearance and specifications of the product may be modified for improvement without notice.

